

BEFORE YOU BEGIN

开始之前

- Congratulation on your purchase of this high quality Bathroom Accessory. Before proceeding with the installation, please carefully read this installation instruction in order to ensure proper care and assembly of this accessory.
- Please keep this installation instruction for future reference.

- 首先恭喜您购买到了高档的卫浴产品，为了使您正确保护和组装产品，在您安装之前请仔细阅读此说明书。

- 请保留此说明书以备参考。

-  Prior to drilling into walls, check there are no hidden electrical wires, cables or water supply pipes with the aid of an electronic detector. If you use power tools do not forget:
1. Wear eye protection.
 2. Unplug equipment after use.

-  警示：在钻孔之前，请借助电子探测仪确认墙内是否有电源线，通讯光缆或者水管之类的东西。如果使用电钻的话请勿忘记以下两点：

1. 请戴上防护镜。
2. 用完设备后关掉电源。

ROUGHING-IN

尺寸图

UNIT : mm
单位：毫米

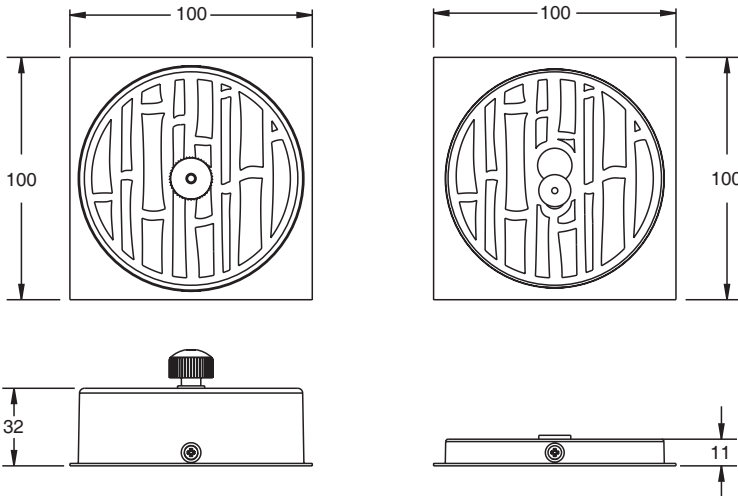

科勒(中国)投资有限公司
上海市闸北区江场三路158号 邮编：200436

INSTALLATION

安装步骤

1. Put the panel at the desired installation place and adjust it to level.

Note: The two panels must be put at the same height.

1. 在希望安装晾衣绳的位置放好背板并调水平。
注意：两个背板必须保持同样的高度。

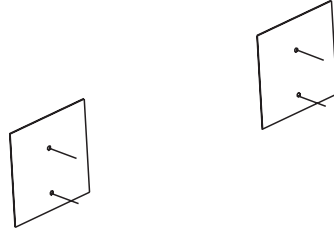

2. Mark the two installation holes on the plates with a pencil.

2. 用铅笔标记出背板上2个孔的位置。

3. Drill two holes at the locations marked with a 6mm drill and the insert the plugs.

3. 用6mm钻头，在2中标记好的位置上钻2个孔，并塞入壁塞。

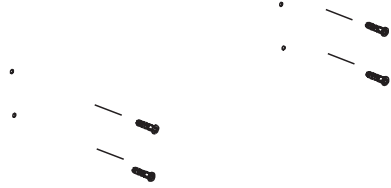

4. Fix the panel and the wall-mount brackets onto wall with screws.

4. 用螺钉将背板和安装片固定在墙面上。

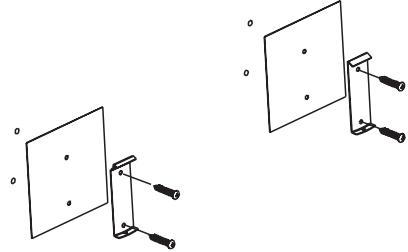

5. Fix the clothesline and the wall-mount brackets with screw b.

5. 用螺钉b将晾衣绳本体和安装片固定在一起。

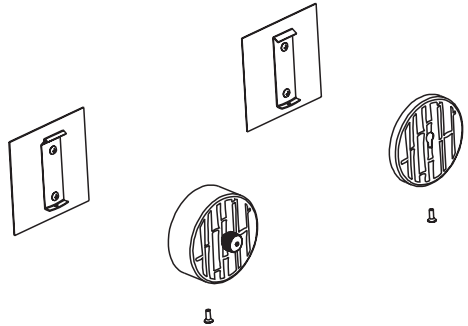

CARING FOR YOUR PRODUCTS

保养须知

The accessories should be washed with warm water and a soft cloth or sponge. Do not use abrasive cleaners or cleaners containing bleach.

为了更好地保养本品，请您用温水和软毛巾(或海绵)擦拭，含有腐蚀性或漂白剂的洗洁剂对本品有害。