

Cairn®

Under-Mount Single-Bowl Farmhouse Kitchen Sink with Tall Apron
K-25786-CM1

Features

- Fits minimum 36" (914 mm) apron sink base cabinet.
- 9-1/2" depth provides generous workspace.
- Matte finish offers rich, dimensional color.
- Solid color throughout the sink.
- Scratch, stain, chip, and thermal-shock resistant.
- Offset drain increases workspace in the sink and storage space underneath.
- Self-Trimming® apron overlaps cabinet face for easy installation and beautiful results.

Material

- KOHLER Neoroc® composite is durable and built to withstand day-to-day cleaning tasks.
- Heat-resistant up to 750°F.

Installation

- Undermount.

Recommended Products/Accessories

- K-8801 Sink drain and strainer with tailpiece
- K-8799 Sink drain and strainer basket

Optional Products/Accessories

- K-11352 Disposal Flange with Stopper
- K-9000 P-Trap

Included Components

- Additional Components:
- K-26026 Farmhouse kitchen sink towel hook
 - K-30182 Sink racks



Codes/Standards









CSA B45.5/IAPMO Z124

KOHLER® Neoroc® Sinks Lifetime Limited Warranty

See website for detailed warranty information.

Available Colors/Finishes

Color tiles intended for reference only.

| Color | Code | Description |
|---|------|------------------|
|  | CM6 | Matte White |
|  | CM7 | Matte Graphite |
|  | CM5 | Matte Beige |
|  | CM8 | Matte Black Plum |
|  | CM1 | Matte Black |
|  | CM2 | Matte Brown |
|  | CM3 | Matte Taupe |
|  | CM4 | Matte Grey |

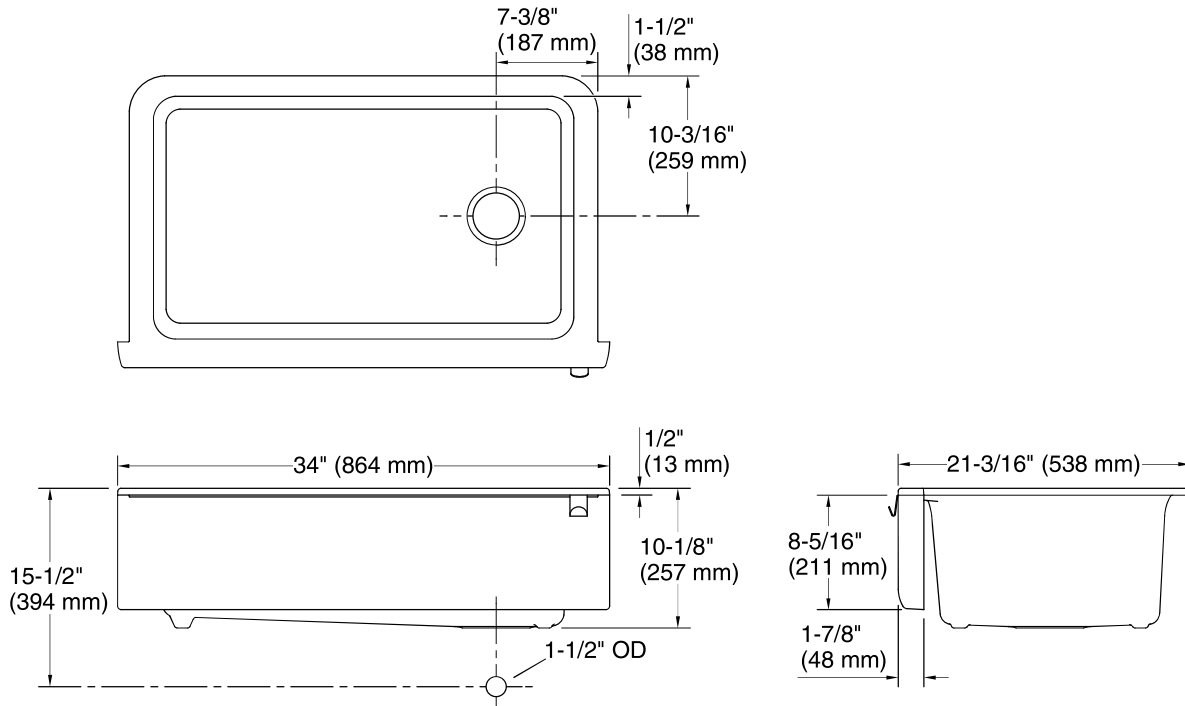

Technical Information

All product dimensions are nominal.

- Bowl configuration: Single
- Installation: Undermount
- Min. base cabinet width: 36" (914 mm)
- Bowl area (Only):
 - Length: 28-5/8" (726 mm)
 - Width: 15-1/2" (394 mm)
 - Bowl depth: 9-1/2" (241 mm)
 - Water depth: 9-1/2" (241 mm)
- Drain hole: 3-7/8" (98 mm)
- Template: Apron-front, 1400299-7, required, included

Notes

Install this product according to the installation instructions.