

安装说明书
Installation Instructions
超能动电池系统
Hybrid Energy System
13683T-NA

上海科勒电子科技有限公司
中国上海市宝山区丰翔路1955号 邮编:200444

KOHLER[®]

安装之前

- 请通读本说明书，以便了解所需工具、材料及安装程序。请遵照相关章节进行安装，以避免由于安装不当而导致不必要的损失。除了有关正确的安装方法之外，还务请详阅所有操作安全说明。
- 本说明书所含一切资料，均以印刷时所有的最新产品为准。科勒中国保留随时更改产品特性、包装或供应情况的权利，恕不另行通知。
- 本说明书包含了有关护理、清洁及保养等重要资料—请交予用户保存。

所需工具及材料

- 卷尺
- 十字螺丝刀
- 电钻

推荐可配产品

- 13462T-CP
- 13463T-CP
- 13468T-CP
- 13469T-CP
- 13474T-CP
- 13475T-CP
- 11603T-CP
- 18093T-CP
- 15538T-CP
- 18076T-CP
- 18078T-CP
- K-4915T-YC05
- K-4915T-C05
- K-4915T-WC05
- K-8787T-B03-CP/SC
- K-8787T-B04-CP/SC
- K-8791T-YC03-CP/SC
- K-8791T-C03-CP/SC
- K-8791T-C04-CP/SC
- K-8988T-C03-CP/SC
- K-8872T-C03-CP
- K-8881T-YC03-BN
- K-16321T-MC05
- K-16320T-MC05

产品规格

1. 电气规格:

输出电压: 3.6V

工作温度范围: $-40^{\circ}\text{C} \sim 85^{\circ}\text{C}$

2. 尺寸规格: 长x宽x高=100mm x 34mm x 37mm

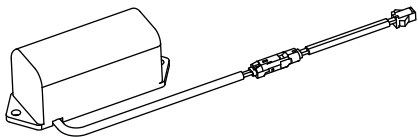

输出电压: 3.6V

安装说明

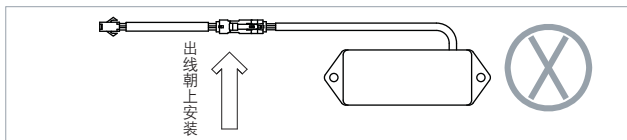
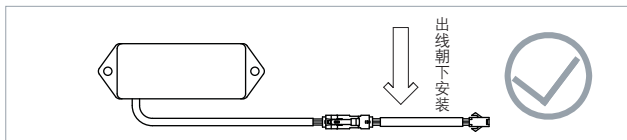

注意: 禁止将电池出线朝上安装。

1. 超能动电池系统配墙出水龙头

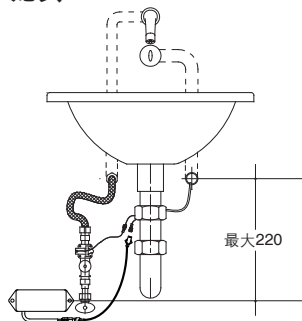
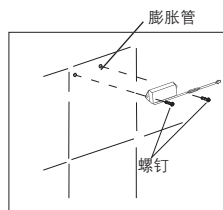

2. 超能动电池系统配台盆龙头

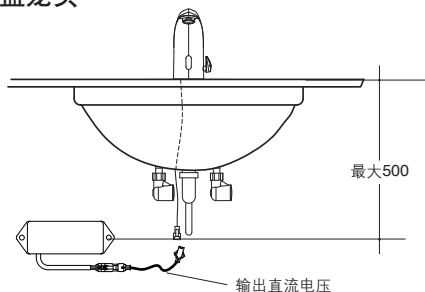
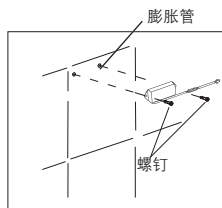

3. 超能动电池系统配小便感应器

A

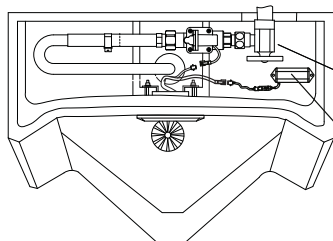

K-4915T-YC05
K-4915T-C05
K-4915T-WC05

B

超能动力电池系统

安装8872T-C03时
接面板上的电控盒

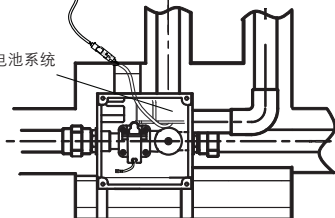

C

超能动力电池系统

安装8881T-YC03-BN时
接面板上的电控盒

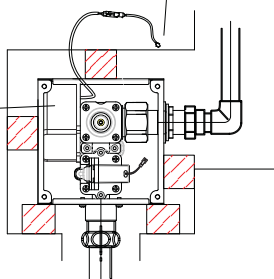

D

超能动力电池系统

安装
8787T-B03
8791T-C03
8988T-C03
8791T-YC03
时接面板上的电控盒

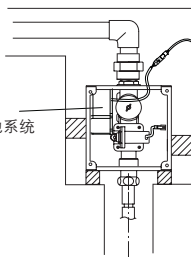

E

超能动电池系统

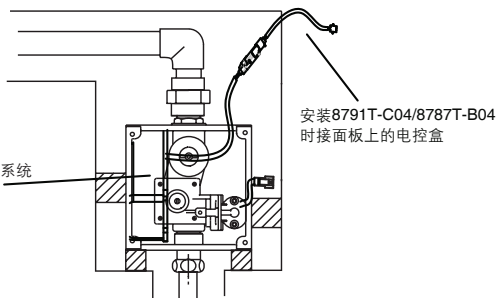

膨胀管

螺钉

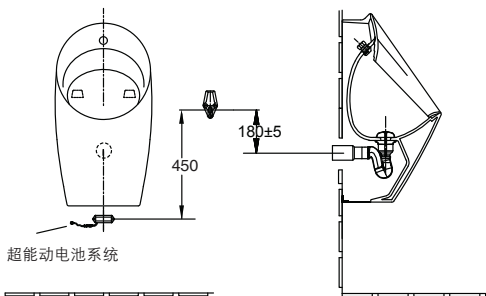
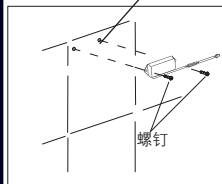

F

用户须知

1. 所有参与安装人员都必须熟知安装说明。
2. 务必按照说明书的要求正确连接电线。
3. 应确保电线连接处无水渗入以及不易受潮。
4. 所有电路连接必须符合相关规范和条例要求。
5. 以下情况将影响电池系统的使用寿命:不当运输、错误安装使用、不可避免的自然灾害及使用科勒不推荐的产品等。

BEFORE YOU BEGIN

- Please read these instructions carefully to familiarize yourself with the required tools, materials, and installation sequences. Follow the sections that pertain to your particular installation. This will help you avoid costly mistakes. In addition to proper installation, read all operating and safety instructions.
- All information in these instructions is based upon the latest product information available at the time of publication. Kohler China reserves the right to make changes in product characteristics, packaging, or availability at any time without notice.
- These instructions contain important care, cleaning, and warranty information-**please leave instructions for the consumer.**

TOOLS AND MATERIALS

- Tape measure
- Screw driver
- Masonry Drill

MATCHES THE PRODUCT

- | | |
|----------------|----------------------|
| • 13462T-CP | • K-4915T-C05 |
| • 13463T-CP | • K-4915T-WC05 |
| • 13468T-CP | • K-8787T-B03-CP/SC |
| • 13469T-CP | • K-8787T-B04-CP/SC |
| • 13474T-CP | • K-8791T-YC03-CP/SC |
| • 13475T-CP | • K-8791T-C03-CP/SC |
| • 11603T-CP | • K-8791T-C04-CP/SC |
| • 18093T-CP | • K-8988T-C03-CP/SC |
| • 15538T-CP | • K-8872T-C03-CP |
| • 18076T-CP | • K-8881T-YC03-BN |
| • 18078T-CP | • K-16321T-MC05 |
| • K-4915T-YC05 | • K-16320T-MC05 |

PRODUCT SPECIFICATION

1. Electrical requirement: 13683T-NA Nominal voltage 3.6
operating temperature range $-40^{\circ}\text{C} \sim 85^{\circ}\text{C}$
2. Dimension requirement: L x W x H = 100mm x 34mm x 37mm.

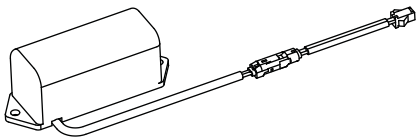

Nominal voltage 3.6

INSTALLATION

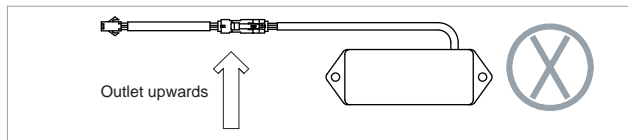
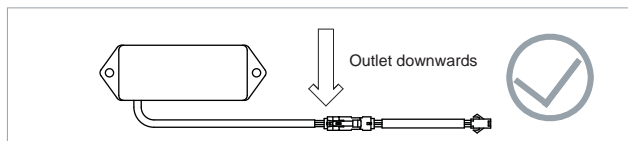

Note: The outlet of power unit is forbidden to be installed upwards.

1. Hybrid Energy System installed with Wall-mount faucet

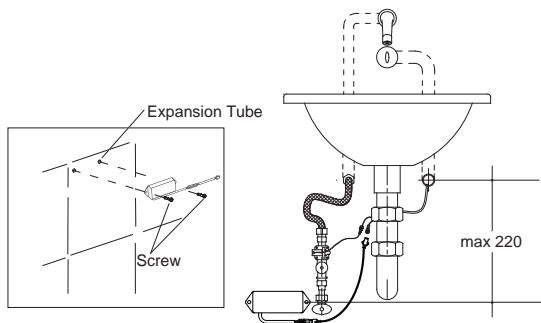

2. Hybrid Energy System installed with Deck-mount faucet

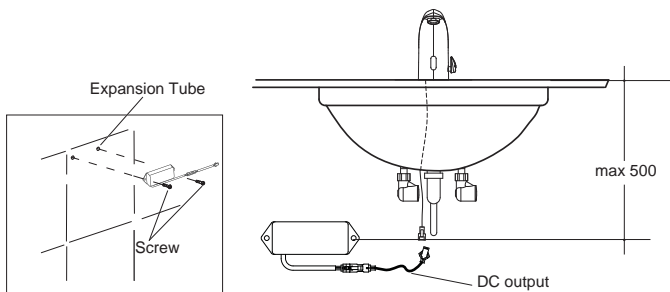

3. Hybrid Energy System installed with Sensor

A

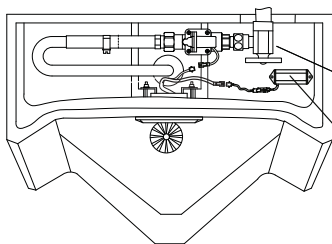

B

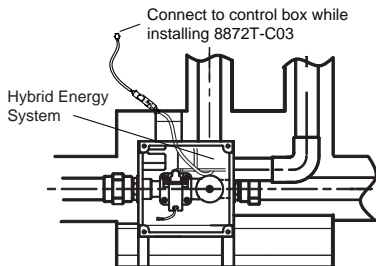

C

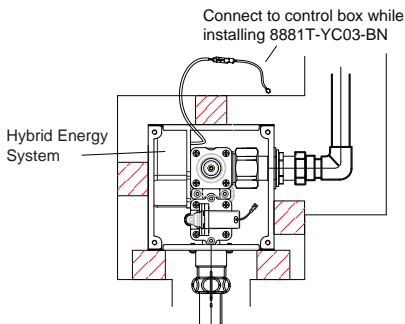

D

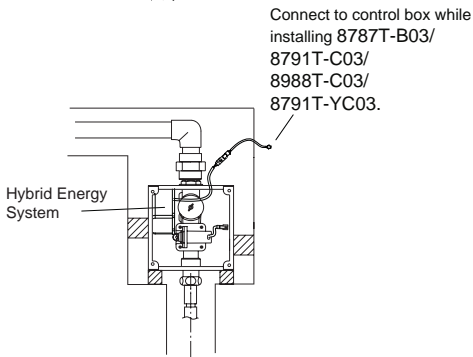

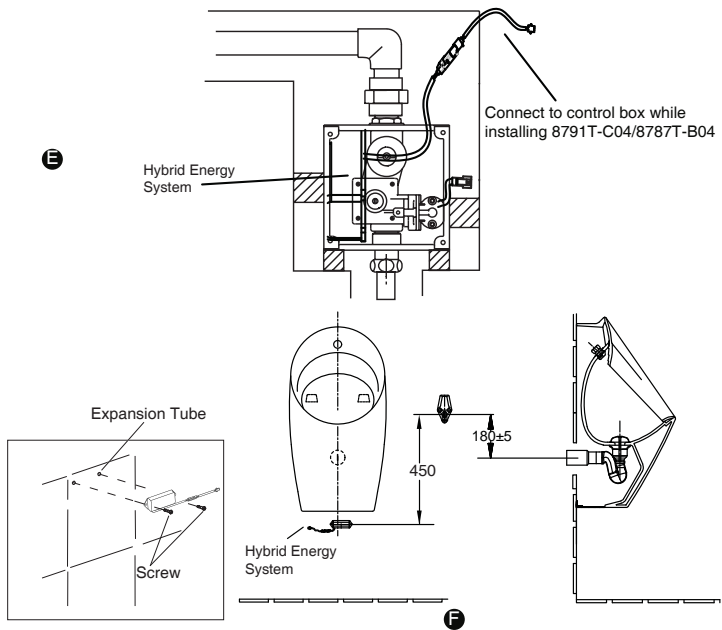

IMPORTANT CONSUMER INFORMATION

1. All installation staff should be well familiar with installation instruction.
2. You must connect wire in exact accordance with installation instructions.
3. Please confirm no water penetration at the connection area of wiring, and the connection area is not easy to be affected by damp.
4. All electrical connection must be compliance with related regulation and codes.
5. The following conditions will affect the battery life: improper transportation, errors installation, inevitable natural disasters or use the products of KOHLER don't recommend, etc.