

KOHLER®

INSTALLATION INSTRUCTIONS

安装说明书

黛诗 TOUCHLESS

Touchless Lavatory Faucet

- 13460T-CP** 经典型单孔混水直流感应面盆龙头
- 13461T-CP** 经典型单孔单冷直流感应面盆龙头
- 13462T-CP** 经典型单孔混水交流感应面盆龙头(无交流电源盒)
- 13463T-CP** 经典型单孔单冷交流感应面盆龙头(无交流电源盒)
- 13464T-CP** 经典型单孔混水交流感应面盆龙头(带交流电源盒)
- 13465T-CP** 经典型单孔单冷交流感应面盆龙头(带交流电源盒)

安装之前

BEFORE YOU BEGIN

所有的资料是按最新出版的产品资料编写而成。科勒公司保留任何时候不经通知即可改变产品特性、包装或产品可供类型的权利。

说明书包括重要的安装、保养及清洁方面的内容，请把这些资料交给用户阅读。

注意事项：

1. 一定要先彻底冲洗供水管以清除管道中的杂质，使用水源为自来水或可供饮用水。
2. 请勿将强力及冲击施于产品，以免造成故障，引起漏水。
3. 安装、清洁龙头时，切勿损伤感应窗口表面，以免造成故障。
4. 对于冷热混水龙头，当您面对龙头时，先将调温把手向前旋至冷水最大状态，再向后缓慢旋转，以免烫伤。
5. 如果是安装新的洗面盆，可将水龙头和排水组件先安装好到面盆上。
6. 对于直流龙头，安装时注意电池的正负极不能装反，电池盒盖要拧紧，防止电池受潮。
7. 对于交流龙头，安装时务必按照说明书的要求正确连接导线，龙头安装完毕后才可向电源盒供电。
8. 一个交流电源盒最多可供两个感应龙头。
9. 交流电的总电源必须有合适熔断丝加以保护。
10. 请勿使产品感应窗口靠近强紫外线或电磁场。
11. 修理面盆时，用黑色电工胶布粘住感应窗口。

All information is based on the latest product information available at the time of publication, Kohler Co. reserves the right to make changes in product characteristics, packaging, or availability at any time without notice. Please leave these instructions for the consumer. They contain important information.

NOTES:

1. Flush the water supply pipes thoroughly to remove debris. Faucet is designed for tap water or potable water.
2. Do not attack the faucet with rough strength to avoid being damaged.
3. Do not damage the surface of sensing window when installing or cleaning the faucet.
4. For hot and cold mixed faucet, please first rotate the handle to the front to cold only, then rotate it back slowly to avoid being scalded by hot water.
5. For new installations, install the faucet and drain to the lavatory before installing the lavatory.
6. As for DC type faucets, please pay special attention to insert direction match of battery poles. Tighten the battery cover completely to prevent its exposure to moisture.
7. As for AC type faucets, strictly follow indicated instructions to perform electric connection. Only provide electric supply to power box after the installation is completed.
8. One AC/DC transformer for max. two faucets.
9. Electrical source must equipped with suitable fuse to protect AC/DC transformer unit from damage.
10. Do not put the faucet near strong ultraviolet or electromagnetic field.
11. Cover the sensing window with black tape when repairing lavatories.

12. 维修交流龙头时，必须断开交流电源并关闭水源。

13. 为保证水龙头正常工作，请务必安装连接件组件。

12. Turn off the electrical source and shut down water supply before the faucets repaired.

13. To ensure the correct operation of the faucet, please do install the connector assy.

使用说明

OPERATION INSTRUCTIONS

1. 手伸到出水口下方感应范围内（感应距离随面盆、周围的情况而自动调节），水龙头出水。手离，0.5~2秒后，水龙头自动止水。

2. 当您面对龙头时，将调温把手向前旋转水温降低，向后旋转水温升高。

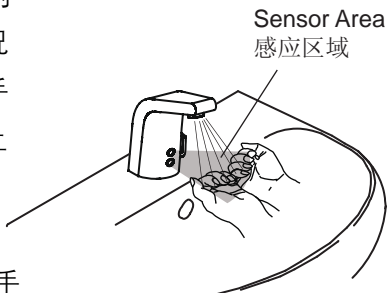

1. Put your hand in the sensing range, the faucet should turn on. The faucet should turn off after removal within 0.5~2 seconds. The sensing distance will be adjusted automatically as per the condition of the lavatory and surrounding environment.

2. Facing the faucet, when rotating the handle to the front, the temperature of outlet water gets lower. When rotating the handle back, the temperature of outlet water gets higher.

安装尺寸

ROUGH-IN DIMENSIONS

单孔混水直流感应面盆龙头
13460T-CP

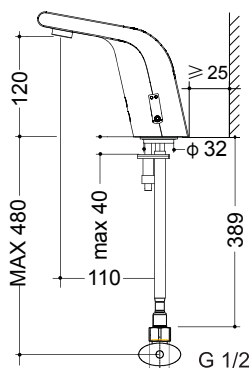

单孔单冷直流感应面盆龙头
13461T-CP

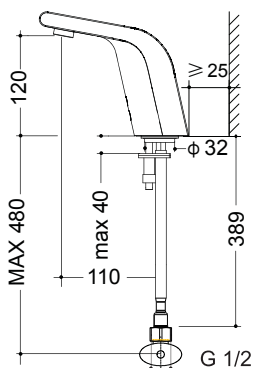

单孔混水交流感应面盆龙头
<不带交流电源盒>
13462T-CP

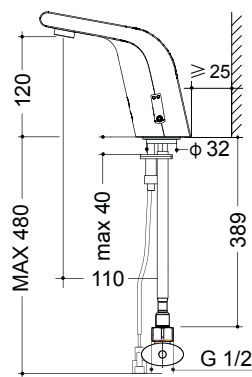

单孔单冷交流感应面盆龙头
<不带交流电源盒>
13463T-CP

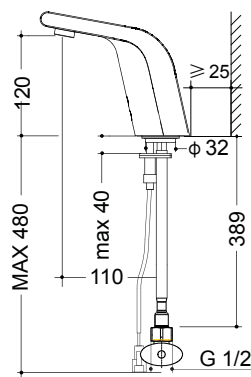

单孔混水交流感应面盆龙头
<带交流电源盒>
13464T-CP

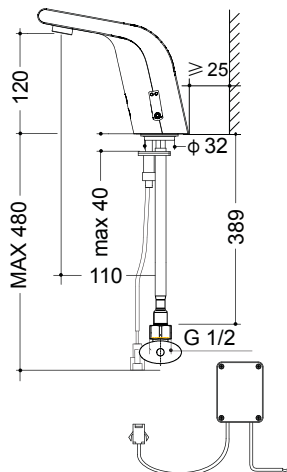

单孔单冷交流感应面盆龙头
<带交流电源盒>
13465T-CP

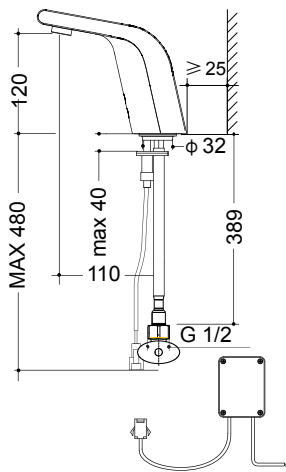

交流电源盒

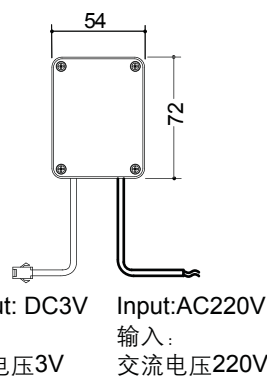

排水组件

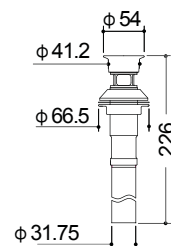

技术参数

电源：直流 2节7号碱性电池(LR03×2)
交流 电压220V,频率50/60HZ
检测时间：小于0.75秒
关阀延时：0.5~2秒
感应距离：自动调节（感应距离调节范围约20~30cm，具体情况可能会随台盆的尺寸不同略有差异。）
流量：水压为0.1MPa时，流量不大于0.125L/s
超时用水控制：超时用水1分钟，自动止水。
环境温度：1~55℃
进水温度：0.5~71℃
适用水压：0.05~0.86MPa

PARAMETERS

Power: DC 2 pieces of AAA size alkaline batteries
AC 220V, 50/60HZ
Sensor Duration: Less than 0.75s
Shut-off Delay: 0.5~2s
Sensing Distance: Automatic adjustment from 20cm to 30 cm. The actual sensor distance will be slightly variable on different lavatories.
Flow Rate: No more than 0.125L/s at 0.1MPa.
Overtime Flowing Control: Automatically stop flushing when the faucet senses an object for more than 1 minute continuously
Ambient Temperature: 1~55℃
Supply Water Temperature: 0.5~71℃
Supply Water Pressure: 0.05~0.86MPa

安装步骤

INSTALLATION

如何安装水龙头

1. 龙头与面盆的安装固定

将随水龙头附带的供水软管(1)旋下。首先将固定螺杆(2)安装到水龙头底部(3)处，再把垫片(4)套在固定螺杆上，并嵌入水龙头底部的盘槽中，然后将电源线(9)（如使用交流型感应龙头）穿过面盆安装孔(5)，将供水软管(1)从面盆下方伸过面盆安装孔(5)，安装到水龙头底部，用手拧紧即可。从面盆下方将固定橡胶垫片(6)固定金属垫片(7)和固定螺母(8)对齐固定螺杆(2)向上套入。调整水龙头电源线(9)及软管位置，用扳手拧紧固定螺母(8)，以便把水龙头固定在面盆上。

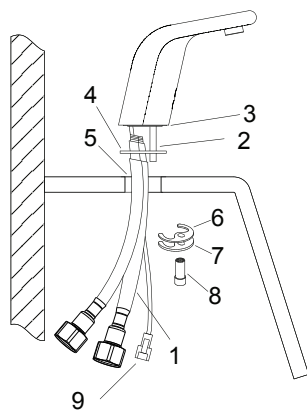

2. 连接件组件的安装固定

将滤网垫片(12)放置在供水管路角阀上。此操作不可遗漏。
将供水软管(1)接到角阀上，拧紧。当您面对水龙头时，左边为热水，右边为冷水。
如果为单冷龙头则只装右边一根供水软管。
注意：将本产品连接上供水管前，建议先冲洗干净供水管。

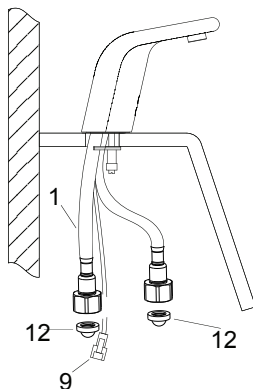

How to Install the Faucet

1. Fixing the faucet and lavatory

Screw off the flexible supply hoses (1) from the faucet. Firstly, install the mounting stud (2) to the bottom of the faucet (3), then slip the washer (4) over the mounting stud, and put it into the groove on the body assembly. Then put wire (9) (used with AC-Faucet) through the basin hole (5). Insert the flexible supply hoses (1) into the hole (5) from underside of the lavatory and tighten them into the faucet holes by hand. From underside of the lavatory, slide the rubber washer (6), metal washer (7) and fixed nut (8) onto the mounting stud (2). Position faucet wire (9) and hoses, tighten nut (8) with a wrench to secure the faucet to the lavatory.

2. Fixing the connector assy

Put the filter washer (12) on the supply angle valve, don't miss it. Connect Supply Hose (1) with supply angle valve and tighten. When facing the faucet, the left hose is hot water, and the right hose is cold water.
For cold only faucet, install the flexible supply hose on the right side only.

警告：若不安装本部件，可能导致龙头损坏或不能正常工作。

NOTE: Please clean the inside of water supply pipe before connecting to the product.

CAUTION: If don't install this kit, the faucet will be damaged or can't work properly.

如何安装排水组件

旋下排水器盘片(13)，在其底面沿周围涂上一圈密封油灰。把排水本体(14)由底下插入面盆。

Apply plumbers putty
涂油灰

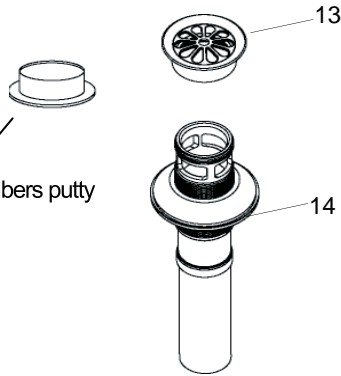

How to Install the Drain

Screw off the drain flange (13) from drain. Apply a ring of plumbers putty around underside of the drain flange(13). Insert the drain body(14) into the lavatory from the underside.

把排水器盘片(13)旋入排水本体(14)。从下方用手拧紧锁紧螺母(15)，去除多余的油灰。

注意：在锁紧螺母(15)拧紧后，不可再调整排水本体的位置，否则会破坏油灰密封。

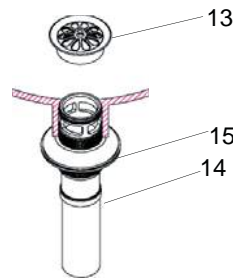

Thread the drain flange (13) onto the drain Body (14). Tighten the locknut (15) by hand from the underside of the fixture. Remove any excess putty.

Note: Do not try to change the position of the drain after the locknut(15) is tightened, or you may break the putty seal.

把尾管(16)接上存水弯(17)，尾管需插入存水弯25mm到55mm之间。

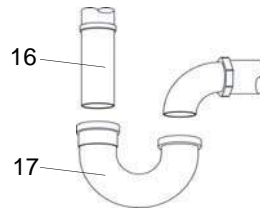

Connect the tailpiece(16) to the trap(17). The tailpiece should extend 25mm to 50mm into the trap.

如何安装交流电源盒 (仅限于交流感应龙头)

HOW TO INSTALL THE AC/DC TRANSFORMER (ONLY USED WITH TOUCHLESS FAUCET, AC)

一个交流电源盒供一个感应龙头
Wire connection pattern for one to one

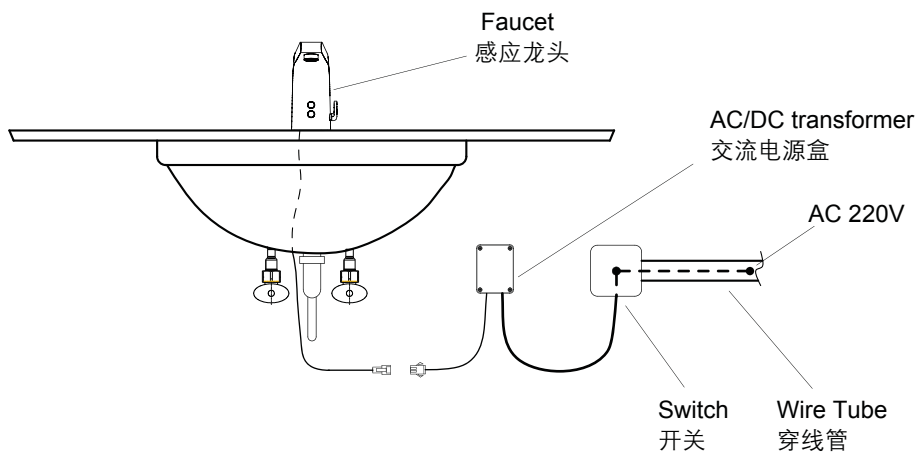

一个交流电源盒供两个感应龙头
Wire connection pattern for one to two

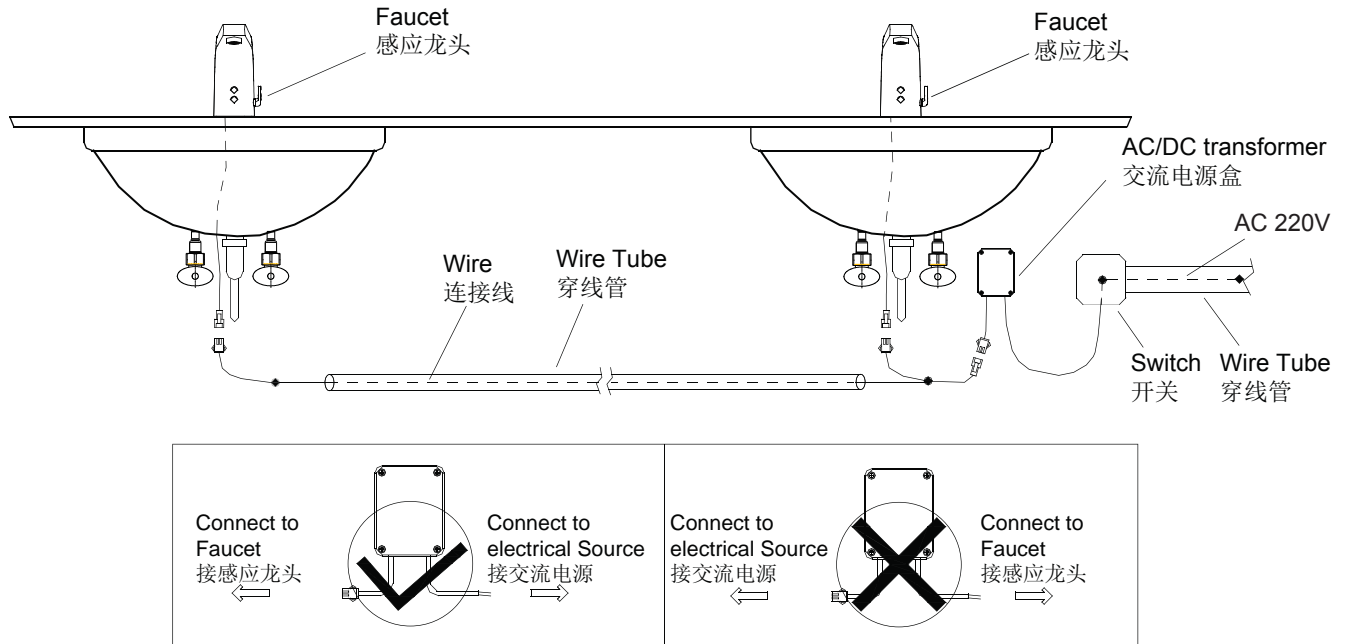

注意：禁止将交流 AC220V 接入直流 DC 接线端。

Note: Not allowed connect AC 220V electrical source to DC wire connector of AC/DC transformer

1.电源盒(背面有不干胶)应安装在干燥, 不会被水淋湿、浸泡的位置。根据需要客户自备穿线管及连接线。穿线管安装在墙内。建议交流电源线采用带绝缘和护套层的电线, 导体标称截面积 $\geq 0.5\text{mm}^2$; 直流连接线采用导体标称截面积 $\geq 0.3\text{mm}^2$ 的电线。请严格按照上图进行连接。

1. Install AC power unit (sticker on the back) dry, and avoid showering, soaking from water. Customer prepare wire tube and wire according to requirement. Wire tube should be put into the wall. Suggested wire: AC connection wire should with insulated protecting layer or sleeve and the section should be bigger than 0.5mm^2 . The section of DC connection wire should be bigger than 0.3mm^2 . The connection pattern must according to illustrations above.

2.排线完毕后, 应检查并确保所有排、接线无误, 再分别连接电源盒AC接线端与排线管内交流接线端, 以及电源盒DC接线端与龙头的电源线接插件, 最后打开AC电源, 龙头进入10分钟自动调距阶段, 此过程龙头不会出水。

2. After wire layout finished, check and repair if needed. Then connect AC connector of AC/DC transformer to electrical source, and DC connector of AC/DC transformer to faucet. Turn on AC electrical power, faucet will be in the period of automatic adjusting sensing distance (about 10 minutes). The faucet will not work during this period.

如何安装、更换电池
(仅限于直流感应龙头)

HOW TO INSTALL AND REPLACE BATTERIES (USED WITH TOUCHLESS FAUCET, DC)

安装、更换电池之前务必清理龙头感应窗口前及面盆内的杂物, 以免影响自动调距, 导致感应距离缩短。
1. 对于调温龙头, 将龙头在台盆上安装完毕后, 用内六角扳手(21)逆时针方向旋松龙头侧面调温把手上

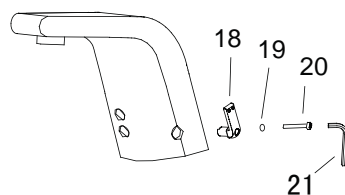

Please remove the objects from the sensing distance and lavatory. Objects in this range will shorten the sensing distance.

1. For temperature adjustment faucet, after installing the faucet on the lavatory, loose the screw (20) on the temp adjustment handle counterclockwise with the hex

的固定螺丝(20)后, 和固定弹簧垫圈(19)、调温把手(18)一起取出。

对于单冷及定温龙头, 直接进行下一步。

2. 用内六角扳手(21)逆时针方向旋松并取出龙头背面的固定螺丝(22)。

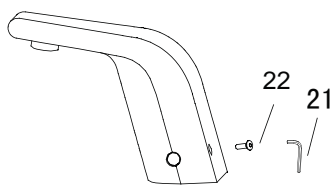

wrench (21). Remove the screw (20), the spring washer (19) and the temp adjustment handle (18).

For cold only and temperature constant faucet, do the next step directly
2. Loose counterclockwise and remove the screw (22) on the back of the faucet with the hex wrench (21).

轻轻向上拔起龙头外壳约6mm后, 感觉到有一定的阻碍时停止, 此时可看到龙头底部的标识(23)。

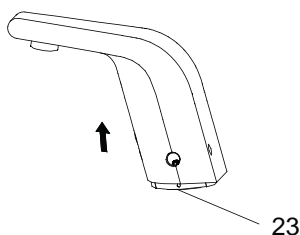

Pull the spout up gently about 6mm. A label (23) will be seen on the valve body when feel blocked.

依照标识所示, 将龙头外壳向前方平移约4mm。

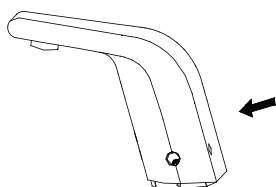

Move the spout forwards about 4mm as the label shown.

再将龙头外壳轻轻向上拔出。

注意: 禁止快速、猛力插拔龙头壳体, 否则将引起电控盒和其他部件损坏。

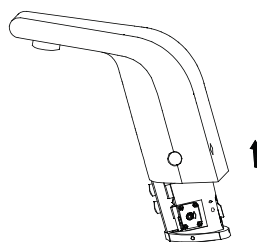

Pull the spout out gently.

Note: Do not pull or insert the spout fleetly and fiercely, otherwise the electronic control box and other parts may be damaged.

3. 用十字螺丝刀将电池盒盖(24)上的螺丝(25)拧出, 并取下电池盒盖(24), 按电池盒盖(24)上的正负极标示装入2节7号碱性电池(26)。

注意: 新旧电池不能混用。

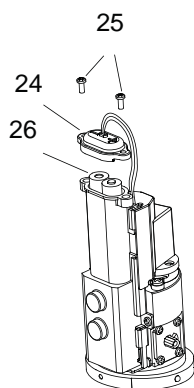

3. Remove the screws (25) on the cover (24) of battery box with a cross-screwdriver. Remove the cover of battery box. Insert 2 pieces of LR03 size alkaline batteries (26) into the battery box according to the pole indication on the cover (24).

Note: Do not mix new and used batteries together.

4. 确认电池盒盖(24)内的O型圈处于O型圈槽内, 将电池盒盖(24)盖上电池盒(27)并拧紧螺丝(25)。注意: 电池盒盖(24)上的缺口(28)与电池盒(27)上的凸筋(29)相对应。螺丝(25)一定要拧紧, 防止电池受潮。

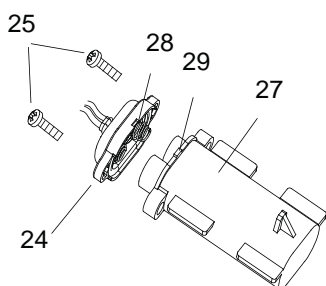

4. Be sure the o-ring in the cover(24) of the battery box is located in the groove, put the cover (24) on the battery box (27) and tighten the screws (25).

Note Put the bulge (29) on the battery box (27) into the gap (28) on the cover (24). Tightenthe screws (25) on the battery box (27) in order to resist water.

5. 将龙头外壳轻轻插向龙头金属底座(30)。

在龙头外壳底部距龙头金属底座(30)约6mm时，将龙头外壳上的两个圆孔感应窗口(31)分别与电控盒上的两个圆凸台(32)对齐，然后将龙头外壳向后平推。

最后再向下推，直至龙头的金属底座(30)完全套入。

6. 将龙头外壳背部的孔对准龙头底座上的螺丝孔，装入固定螺丝(22)，用内六角扳手(21)顺时针方向旋紧。
注意:对于调温龙头，还需以下步骤。

7. 将调温把手(18)按如图所示方向插入调温把手孔位，逆时针方向旋至不可旋为止，取出调温把手(18)。

8. 将调温把手(18)如图所示方向插入调温把手孔，装入固定弹簧垫圈(19)、固定螺丝(20)，用内六角扳手(21)顺时针方向拧紧。

注意: 安装或更换电池后，龙头进入10分钟自动调距阶段，此过程龙头不会出水。

9 更换电池

发现感应指示灯间隔2秒钟连续闪烁，代表电池耗尽，已停止工作，请按上述步骤1~8更换电池。

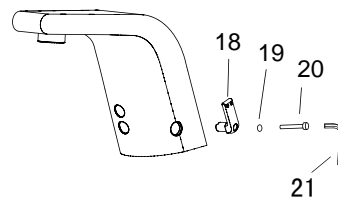
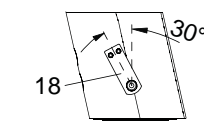
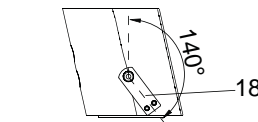
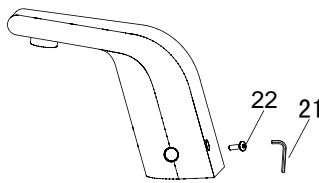
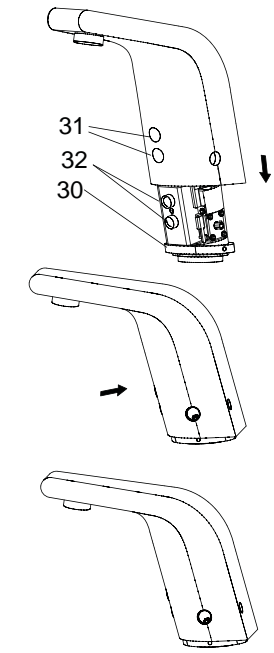

5. Insert the spout to the valve body of the faucet (30) gently.

Move the spout backwards, and put the bulge (32) of the control box into the sensor window when the distance between the bottom of the spout and the valve body is about 6mm.

Finally, push the spout down completely.

6. Align the hole on the back of spout to the screw hole on the bottom of the valve body. Insert the screw (22) and tighten it clockwise with the hex wrench(21).
Note: Following steps are needed for temperature adjustment faucet.

7. Insert the temp adjustment handle (18) to the handle hole in accordance with the direction as the figure shown, then rotate the temp adjustment handle counterclockwise until it can not be rotated any more and take it out.

8. Insert the temp adjustment handle (18) to the handle hole in accordance with the direction as the figure shown. Insert the screw (20) along with the spring washer (19). Tighten clockwise the screw with the hex wrench (21).

Note: After installing or replacing batteries, the faucet will be in the period of automatic adjusting sensing distance(about 10 minutes). The faucet will not work during this period.

9. Replace batteries:

If the indicator flashes every 2 seconds, the batteries are out of power. The faucet will not work. Replace batteries per the steps 1~8 above.

安装结果检查

1. 检查并确保所有衔接处都已拧紧，打开排水系统和主要供水源，检查并修理有漏水的接口。

2. 十分钟自动调距结束后，将调温把手旋至其调温范围中间位置（调温龙头），用起泡器钥匙(34)插入起泡器槽口，逆时针方向旋下起泡器(33)，手伸到出水口下方感应范围内让水流出约一分钟以清除杂质。冲洗起泡器，在关闭主要供水源后，重新装回起泡器(33)。最后打开主要供水源。

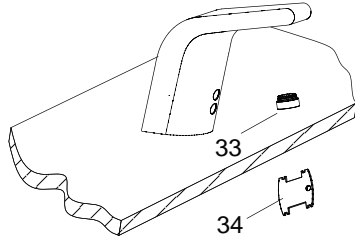

INSTALLATION CHECKOUT

1. Check and ensure that all connections are tight. Open the drain. Turn on main water supply and check for leaks. Replace as required.
2. After power on for 10 minutes, turn the handle to the middle position of the temp adjusting range (For mixed faucet). Insert the aerator key(34) into the aerator slot and take off the aerator (33) by rotating it counter-clockwise. Put hands into the sensing range under the outlet. Flush water through the faucet for about 1 minuteto remove any debris. Remove any debris from the aerator assembly (33). Shut the main water supply and reinstall the aerator assembly (33). Finally, open the main water supply.

清理说明

适用于所有加工处理过的表面，以中性肥皂水清洗镀层表面，再以干净的软布彻底擦干整个表面。许多清洁剂，比如氨水，去污粉及洁厕灵等，会对电镀表面造成伤害，切忌使用。

有腐蚀性的清洁剂或溶剂不可使用于科勒的水龙头及其配件上。

CLEANING INSTRUCTIONS

All Finishes: Clean the finish with a mild soap and warm water. Wipe entire surface completely dry with a clean soft cloth. Many cleaners may contain chemicals, such as ammonia, chlorine, toilet cleaner etc. which could adversely affect the finish and are not recommended for cleaning. Do not use abrasive cleaners or solvents on Kohler faucets and fittings.

如何设定调温龙头的调温范围

1. 逆时针旋转调温把手至不可旋为止，用内六角扳手(21)逆时针方向旋松调温把手上的固定螺丝(20)后，将固定螺丝(20)、固定弹簧垫片(19)、调温把手(18)一起取出。

注意：拧松螺丝(20)时不要转动调温把手(18)。

2. 将调温把手(18)如图(1)所示方向插入调温把手孔，此时调温龙头的调温范围最大，调温把手的最大可旋转角度约为110°，龙头最高出水温度约为热水供应温度。



图 (1)

HOW TO SETUP TEMPERATURE ADJUSTMENT RANGE

1. Rotate the temp adjustment handle Counterclockwise until it can not be rotated. Loose the screw(20) on the temp adjustment handle(18) counterclockwise with the hex wrench (21). Remove the screw(20) and the spring washer(19) along with the temp adjustment handle (18).

Note: Do not rotate the temp adjustment handle(18) when loosening the screw.

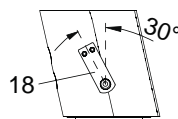
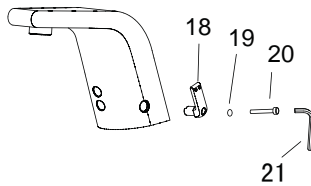
2. Insert the temp adjustment handle (18) in the handle hole in accordance with the direction as figure (1) shown. At this position, the faucet has the maximum temperature adjustment range. The maximum rotating range is about 110°. The highest water temperature is almost same as the temperature of hot water supplied.

将调温把手(18)如图(2)所示方向插入调温把手孔,此时调温龙头的温范围最小,调温把手的可旋转角度约为0°,仅能出冷水。



图 (2)

Insert the temp adjustment handle (18) to the handle hole in accordance with the direction as figure (2) shown. At this position, the faucet has the minimum temperature adjustment range. The maximum rotating range is about 0°. Only cold water out.

把手安装角度与龙头调温范围的关系如图所示(3)。

Increase temp adjustment range and highest water temperature
调温范围增大,最高出水温度升高

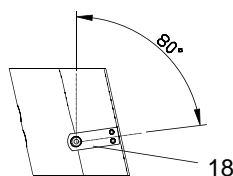
Decrease temp adjustment range and highest water temperature
调温范围减小,最高出水温度降低



图 (3)

The relationship between the pre-set angle of the handle (18) and the temp adjustment range is shown as figure (3).

3. 装入固定弹簧垫圈 (19)、固定螺丝(20),用内六角扳手(21)顺时针方向拧紧。

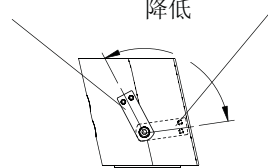
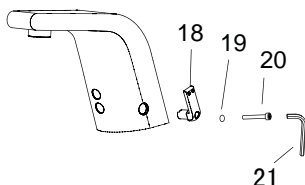

3. Insert the screw (20) along with the spring washer (19). Tighten the screw clockwise with the hex wrench (21).

用户须知

IMPORTANT CONSUMER INFORMATION

1. 感应指示灯的各种闪烁情况

感应指示灯是使用者了解感应龙头有效、唯一的途径。所以明白了感应指示灯闪烁所代表的含义,可以正确使用感应龙头:

(1) 快速闪烁,代表感应龙头正处于通电后的十分钟自动调节阶段。期间,安装者、使用者不得干扰其自动调节,感应范围内不要放置物体。

(2) 间隔约2秒钟连续闪烁:若直流感应龙头,代表龙头电池耗尽,已停止工作,等待使用者更换电池;若交流感应龙头,表示为两种情况:一种为刚刚停电;另一种为在交流供电正常的情况下,则电源盒直流接线端接触不良。

1. Note of the Indicator Flashing

The indicator is the only and effective way to learn the faucet's working conditions. So the users can use the sensor faucet correctly with knowing the meaning of the sensor indicator's flashing.

(1) Fast flashing means the faucet is in the period of adjusting sensing distance after power on for 10 minutes. During these 10 minutes, please do not put objects in the sensing range.

(2) The indicator flashes every 2seconds: As for DC type faucets, the symptom indicates that the unit is out of battery and ceases working. Recommend to replace batteries. As for AC type faucets, there're two possibilities. One possibility is that the unit is out of battery while the other is that bad wire connection occurs to DC terminal of the power box provided AC supply functions normally.

(3) 在正常工作情况下，当有物体被感应时，龙头出水，感应指示灯闪烁一次。（龙头关闭，感应指示灯不闪烁。）

(3) In normal condition, the water will flow and the indicator will flash one time when objects are inducted. (The indicator does not flash when faucet stops flowing.)

2. 超时出水控制

连续在感应状态下使用约一分钟，龙头自动止水。自动止水后，手或物体离开感应范围后，再次进入感应范围内，龙头正常工作，否则无反应。

2. Overtime Flowing Control

When the faucet works for about 1 minute continuously, the water will be shut off automatically. After that, objects must be removed from the sensing range. Then the water will flow when objects go into the sensing range again. Otherwise, the faucet will not work.

3. 自动止水智能控制

物体进入感应范围内被感知，龙头自动出水。若15秒钟静止不动，水龙头自动止水。自动止水后，手或物体离开感应范围后，再次进入感应范围内，水龙头正常工作，否则无反应。

3. Intelligent Stopping Flowing

Water will flow out when object are putted into the sensing range. If the objects hold still for 15 seconds, the faucet will shut off automatically. After that, objects must be removed from the sensing range. Then the water will flow when objects go into the sensing range again. Otherwise, the faucet will not work.

4. 清洗过滤系统

该感应龙头的连接件内已包含了过滤装置。如管内杂质过多或水质较差，长期使用会引起出水情况不良。请按以下步骤清洗过滤装置：拆下进水软管，将滤网垫片取出，冲洗完毕后逆转装入。必要时，也可旋下龙头起泡器，冲洗干净后重新旋紧。从而改善出水情况。



4. Clean the Filtration System

The faucet includes connector assembly with filtration system. If there is a lot of debris in the supply pipes or the quality of water is bad, it will cause the flow in bad condition. Please clean the filtration system as following steps: Remove the supply hose and take out the filter washer to take a rinse. Assemble them back in the reverse order.

If necessary, you can screw off and clean the aerator of the faucet, then reinstall it to improve the flow condition.

常见故障排除

以下部分故障现象可通过指示灯闪烁情况识别。（参考“感应指示灯的各种闪烁情况”）

现象	原因	处理方法
不出水 (感应指示灯不闪烁)	无电池或电池装反(直流电) 无电源或接线有误(交流电) 感应范围内有其它物体 感应窗口较脏 接线端未插好、插错	检查电池 检查总电源和接线情况 移开物体 清洁窗口 检查接线端
感应指示灯每2秒快速 闪烁1次而不出水	电池耗尽(直流电) 刚刚停电(交流电) 直流或交流接线端接触不良(交流电)	更换电池 检查总电源 重新连接接插件
感应指示灯闪烁 不出水	刚装机完毕 角阀关闭 起泡器脏堵	等待10分钟 打开角阀 清洗起泡器
感应指示灯闪烁 出水量小	角阀是否彻底打开 过滤装置堵塞 起泡器脏 水压太低	彻底打开角阀 清洗过滤装置 清洗起泡器 检查供水系统
约一分钟以内不止水 (感应指示灯不闪烁)	感应范围内有物体	移开物体

如按以上操作仍未解除故障，请与销售商或科勒(中国)投资有限公司联系。

除安装更换电池外，请勿随意拆卸龙头其它部件。

TROUBLE SHOOTING

Some trouble symptoms can be identified by the indicator's flashing. (Refer to "Note of the Indicator Flashing")

Symptoms	Probable Causes	Corrective Action
No water flow (Indicator not flashing)	No battery or wrongly connected No power supply or wrong connection Object in sensing range Dirt on the sensing window The connector does not connect well	Check the batteries Check the power supply and the connection Remove the object Clean the sensing window Check the connector
The indicator flashes once every 2 seconds and the water doesn't flow out.	Batteries are out of power Just power cut DC or AC connector of AC/DC transformer may not connect well	Replace batteries Check the power supply Reconnect the connector
No water flow while the indicator flashes	Just finishing installation Angle valve is closed Aerator is blocked	Wait for 10 minutes Open the angle valve Clean the aerator
Low water flow while the indicator does not flash	Angle valve is not open completely The filter is blocked Aerator is dirty The supply water pressure is lower	Open the angle valve completely Clean filter Clean the aerator Check the water supply system
Keep water out within 1 minute while indicator does not flash	Object in sensing range	Remove object

Please contact with distributor or Kohler China Investment Co., Ltd., if the trouble remains after above-mentioned actions are taken. Please do not disassembly the other parts of the faucet freely except installing and replacing batteries.

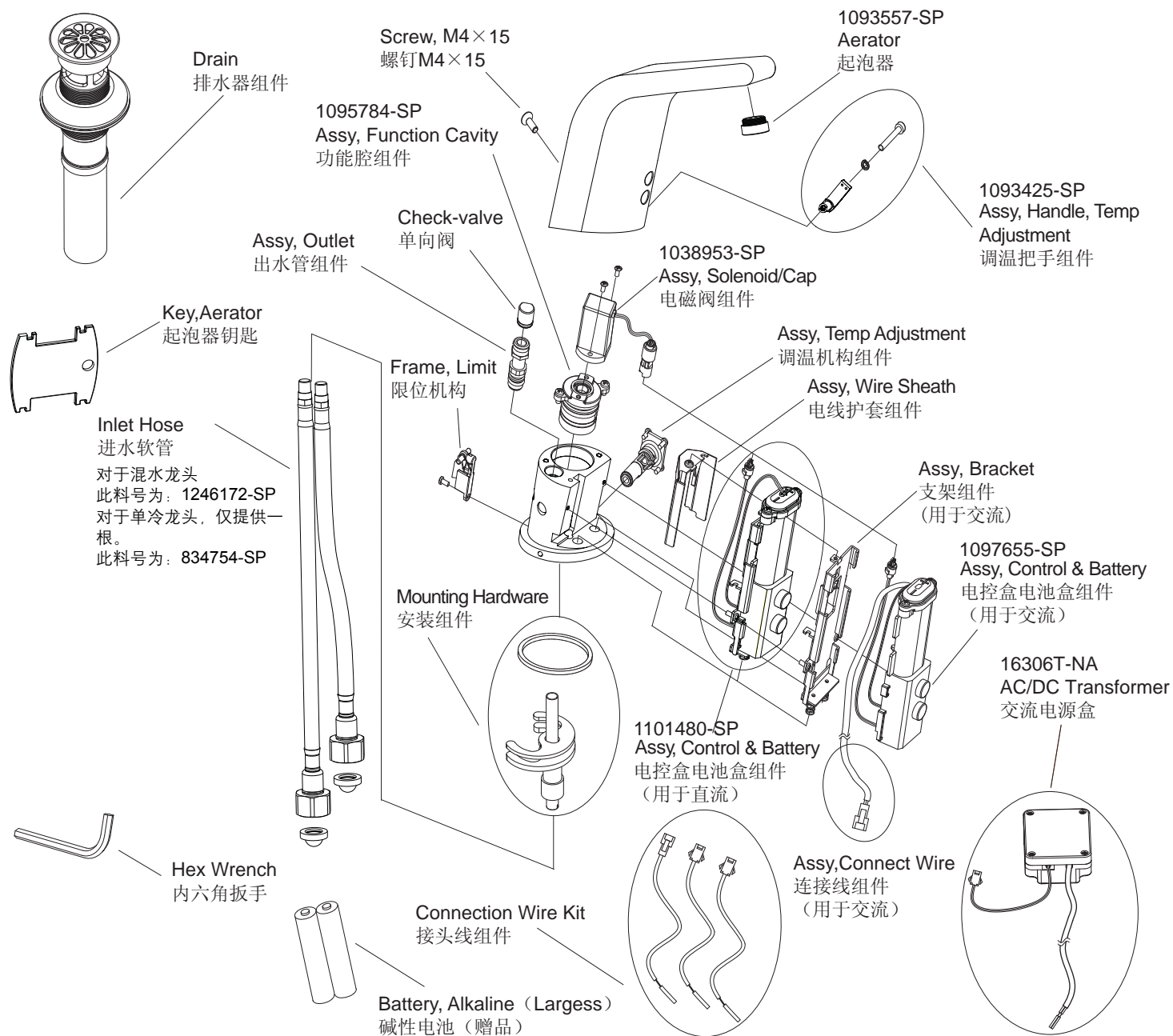

注: 1097655-SP 仅用于13462T-CP、13463T-CP、13464T-CP、13465T-CP;
 交流电源盒仅用于13464T-CP、13465T-CP; 1068120仅用于13462T-CP、13463T-CP;
 1101480-SP仅用于13460T-CP、13461T-CP;
 1093425-SP仅用于13460T-CP、13462T-CP、13464T-CP.